

EKONOMYLED *Elegance*

 **KROS**  
ELETTRONICA



**Codice:** 09680

**Articolo:** EKE100NC40SE44

**Descrizione:** Plafoniera d'emergenza S.E. IP44

## SPECIFICHE TECNICHE

TECHNICAL SPECIFICATIONS

<b>Fabbricazione elettronica LED</b> Manufacturing LED electronics	Italiana KROS 100% Italian KROS
<b>Alimentazione</b> Input power	230Vca-50Hz
<b>Assorbimento</b> Power consumption	3W
<b>Grado di protezione</b> Protection degree	IP 44
<b>Corpo</b> Body	ABS-policarbonato autoestinguente V2 conforme alle normative vigenti Self-extinguishing (V2) ABS plastic material
<b>Ottica</b> Reflector	Policarbonato prismaticizzato autoestinguente V2 Self-extinguishing (V2) prismaticized polycarbonate
<b>Fonte luminosa</b> Light source	LED Micro 150 Lumen/1W
<b>Flusso luminoso nominale</b> Luminous flux	100 Lumen
<b>Temperatura operativa</b> Operating temperature	-5°C+50°C
<b>Resa cromatica (CRI)</b> Colour Rendering Index	75-90
<b>Tipo di funzionamento</b> Type of functioning	S.E. Not permanent

<b>Classe di isolamento</b> Insulation class	II
<b>Dimensioni</b> Dimensions	350x170x60mm
<b>Autonomia</b> Autonomy	4 h
<b>Tempo di ricarica</b> Recharge time	12 h
<b>Montaggio*</b> Mounting*	A parete Wall
<b>*ad incasso tramite art.WALL-BOX-V2 (cod.09716)</b> *Recessed wall mounting by item WALL-BOX-V2 (cod.09716)	
<b>Batteria</b> Battery	Ni-Cd Ricaricabile Rechargeable Ni-Cd
<b>Ricarica della batteria a corrente costante</b> Battery recharging at constant rated current	
<b>Protezione della batteria a scarica completa</b> Battery protection at full discharging	
<b>LED Verde spia presenza rete</b>	
GREEN LED power ON	
<b>Garanzia sulla fonte luminosa</b>	<b>10 anni</b>

### Diagramma polare

Polar diagram

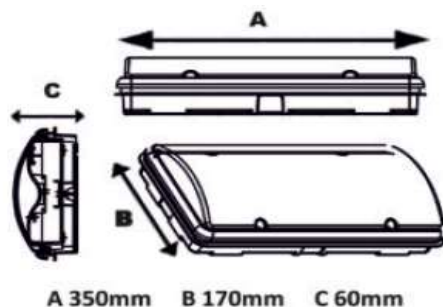
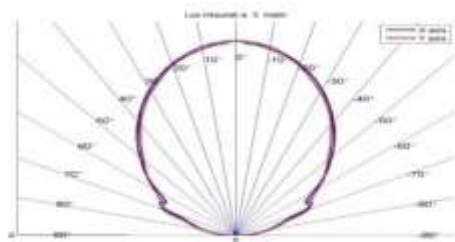

ELETTRONICA KROS S.r.l.

Stabilimento produttivo Via della Produzione 15 - 00030 San Cesario Roma (Italy) - Tel. +39 06 9588359 - www.krossrl.it