

**EKONOMYFLAG**

Visibilità Segnaletica 32 m.

**Codice:** 09426**Articolo:** FKP300NC10SE65**Descrizione:** Plafoniera d'emergenza a bandiera S.E.  
IP 65 Serie EKONOMY FLAG**SPECIFICHE TECNICHE**

TECHNICAL SPECIFICATIONS

<b>Fabbricazione elettronica LED</b> Manufacturing LED electronics	Italiana Italian	<b>Dimensioni Targa</b> plate Dimensions	180x290x10 mm
<b>Alimentazione</b> Input power	230Vca-50Hz	<b>Dimensioni lampada</b> Dimensions	350x170x60 mm
<b>Assorbimento</b> Power consumption	2W	<b>Autonomia</b> Autonomy	1 h
<b>Grado di protezione</b> Protection degree	IP 65	<b>Tempo di ricarica</b> Recharge time	12 h
<b>Corpo lampada</b> Body	Polycarbonato autoestinguente V2 conforme alle normative vigenti Self-extinguishing (V2) plastic material	<b>Montaggio*</b> Mounting*	A soffitto Ceiling
<b>Ottica</b> Reflector	Polycarbonato prismaticizzato autoestinguente V2 Self-extinguishing (V2) prismaticized polycarbonate	<b>Targa</b> Plate	Plexiglass Colato Cast Plexiglass
<b>Fonte luminosa</b> Light source	LED Micro 150 Lumen/1W	<b>Supporto Targa</b> Plate support	Acciaio Inox Stainless Steel
<b>Flusso luminoso SE/SA</b> Luminous flux	300 Lumen	<b>Batteria</b> Battery	Ni-Cd Ricaricabile Rechargeable Ni-Cd
<b>Temperatura operativa</b> Operating temperature	-5°C+50°C	<b>Ricarica della batteria a corrente costante</b> Battery recharging at constant rated current	
<b>Resa cromatica (CRI)</b> Colour Rendering Index	75-90	<b>Protezione della batteria a scarica completa</b> Battery protection at full discharging	
<b>Tipo di funzionamento</b> Type of functioning	S.E. Not Permanent	<b>LED Verde spia presenza rete</b> GREEN LED power ON	
		<b>Garanzia sulla Fonte Luminosa</b> Light Source Warranty	<b>10 ANNI</b>

**Diagramma polare Lampada**

Lamp Polar diagram

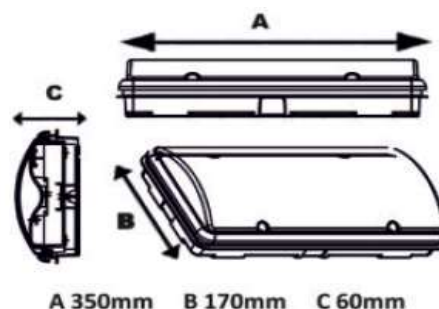
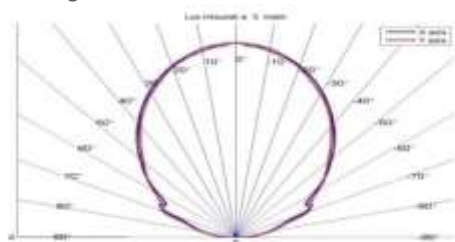

ELETTRONICA KROS S.r.l.

Stabilimento produttivo in Via della Produzione, 15 - 00030 San Cesario Roma (Italy) - Tel. +39 06 9588359 - www.krossrl.it