

EKONOMYLED *Elegance*

 **KROS**
ELETTRONICA



Codice: 09707

Articolo: EKE250NC10SA44

Descrizione: Plafoniera d'emergenza S.A. IP44

SPECIFICHE TECNICHE

TECHNICAL SPECIFICATIONS

Fabbricazione elettronica LED Manufacturing LED electronics	Italiana KROS 100% Italian KROS
Alimentazione Input power	230Vca-50Hz
Assorbimento Power consumption	3W
Grado di protezione Protection degree	IP 44
Corpo Body	ABS-policarbonato autoestinguente V2 conforme alle normative vigenti Self-extinguishing (V2) ABS plastic material
Ottica Reflector	Policarbonato prismatico autoestinguente V2 Self-extinguishing (V2) prismatic polycarbonate
Fonte luminosa Light source	LED Micro 150 Lumen/1W
Flusso luminoso nominale Luminous flux	250 Lumen
Temperatura operativa Operating temperature	-5°C+50°C
Resa cromatica (CRI) Colour Rendering Index	75-90
Tipo di funzionamento Type of functioning	S.A. Permanent

Classe di isolamento Insulation class	II
Dimensioni Dimensions	350x170x60mm
Autonomia Autonomy	1 h
Tempo di ricarica Recharge time	12 h
Montaggio* Mounting*	A parete Wall
*ad incasso tramite art.WALL-BOX-V2 (cod.09716) *Recessed wall mounting by item WALL-BOX-V2 (cod.09716)	
Batteria Battery	Ni-Cd Ricaricabile Rechargeable Ni-Cd
Ricarica della batteria a corrente costante Battery recharging at constant rated current	
Protezione della batteria a scarica completa Battery protection at full discharging	
LED Verde spia presenza rete	
GREEN LED power ON	
Garanzia sulla fonte luminosa	10 anni

Diagramma polare

Polar diagram

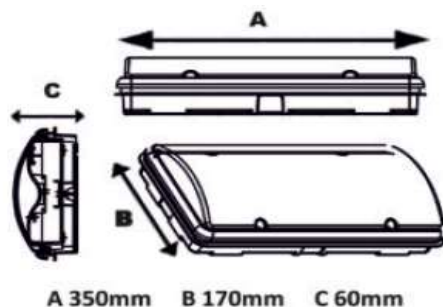
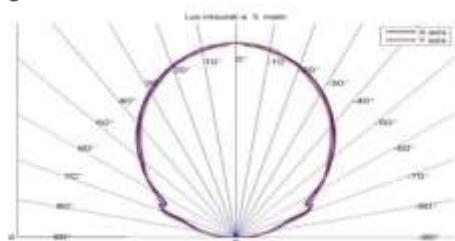

ELETTRONICA KROS S.r.l.

Stabilimento produttivo Via della Produzione 15 - 00030 San Cesario Roma (Italy) - Tel. +39 06 9588359 - www.krossrl.it