

EKONOMYFLAG

Visibilità Segnaletica 32 m.

**Codice:** 09669**Articolo:** FKP400NC30SA65**Descrizione:** Plafoniera d'emergenza a bandiera S.A.
IP 65 Serie EKONOMY FLAG**SPECIFICHE TECNICHE**

TECHNICAL SPECIFICATIONS

Fabbricazione elettronica LED Manufacturing LED electronics	Italiana Italian	Dimensioni Targa plate Dimensions	180x290x10 mm
Alimentazione Input power	230Vca-50Hz	Dimensioni lampada Dimensions	350x170x60 mm
Assorbimento Power consumption	2W	Autonomia Autonomy	3 h
Grado di protezione Protection degree	IP 65	Tempo di ricarica Recharge time	12 h
Corpo lampada Body	Polycarbonato autoestinguente V2 conforme alle normative vigenti Self-extinguishing (V2) plastic material	Montaggio* Mounting*	A soffitto Ceiling
Ottica Reflector	Polycarbonato prismatico autoestinguente V2 Self-extinguishing (V2) prismatic polycarbonate	Targa Plate	Plexiglass Colato Cast Plexiglass
Fonte luminosa Light source	LED Micro 150 Lumen/1W	Supporto Targa Plate support	Acciaio Inox Stainless Steel
Flusso luminoso SE/SA Luminous flux	400 Lumen	Batteria Battery	Ni-Cd Ricaricabile Rechargeable Ni-Cd
Temperatura operativa Operating temperature	-5°C+50°C	Ricarica della batteria a corrente costante Battery recharging at constant rated current	
Resa cromatica (CRI) Colour Rendering Index	75-90	Protezione della batteria a scarica completa Battery protection at full discharging	
Tipo di funzionamento Type of functioning	S.A. Permanent	LED Verde spia presenza rete GREEN LED power ON	
		Garanzia sulla Fonte Luminosa Light Source Warranty	10 ANNI

Diagramma polare Lampada

Lamp Polar diagram

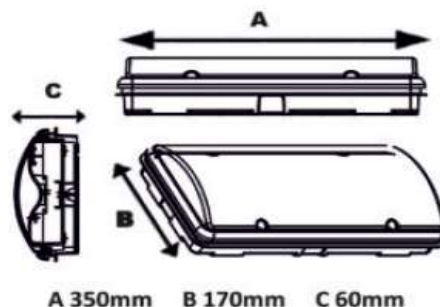
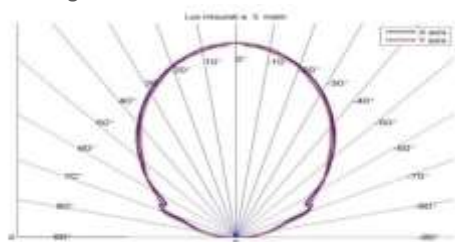

ELETTRONICA KROS S.r.l.

Stabilimento produttivo in Via della Produzione, 15 - 00030 San Cesario Roma (Italy) - Tel. +39 06 9588359 - www.krossrl.it